



P/N: 15G065098000AK V1.0

Quick Installation Guide



Mezzanine PHY Card Series

Introduction

Thank you for purchasing ASRock Rack mezzanine card, a reliable mezzanine card produced under ASRock Rack's consistently stringent quality control. It delivers excellent performance with robust design conforming to ASRock Rack's commitment to quality and endurance.

Model	Dimension	Interface / Connector	PHY Chip
MP-1543R4	4.3" x 2.8" (110 x 71.01 mm)	1Gbps (4x KX host connection via OCP PHY Mezzanine Connector C) / 4 x RJ-45	Marvell 88E1543
MP-557R2	4.3" x 2.8" (110 x 71.01 mm)	10Gbps (2x KR host connection via OCP PHY Mezzanine Connector C) / 2 x RJ-45	Intel X557-AT2
MP-4223R4	4.3" x 2.8" (110 x 71.01 mm)	10Gbps (4x KR host connection via OCP PHY Mezzanine Connector C) / 4 x 10G SFP+ (Fiber)	Inphi CS4223
MP-4227R2	4.3" x 2.8" (110 x 71.01 mm)	10Gbps (2x KR host connection via OCP PHY Mezzanine Connector C) / 2 x 10G SFP+ (Fiber)	Inphi CS4227

Package Contents

- 1 x Mezzanine PHY Card
- 4 x Spacer Supports
- 1 x Quick Installation Guide

MP-1543R4

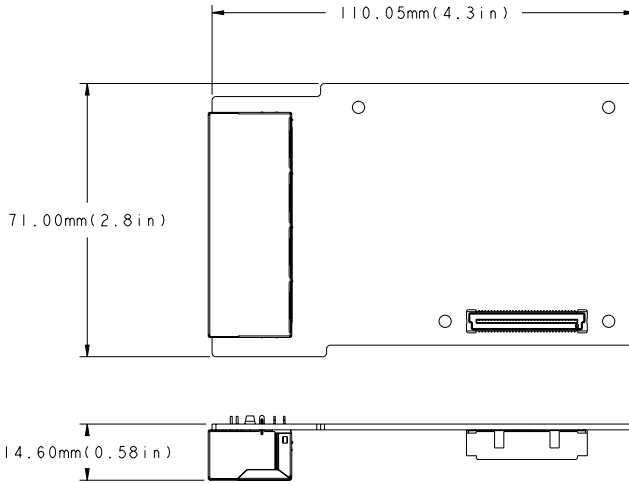

Layout

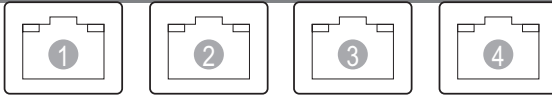

- | | | | |
|---|------------------------|---|------------------------|
| 1 | LAN RJ-45 Ports (LAN4) | 3 | LAN RJ-45 Ports (LAN2) |
| 2 | LAN RJ-45 Ports (LAN3) | 4 | LAN RJ-45 Ports (LAN1) |

LAN Port LED Indications

Activity / Link LED

Status	Description
Off	No Link
Blinking	Data Activity
On	Link

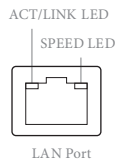

Speed LED

Status	Description
Off	No connection
Green	1Gbps connection

MP-557R2

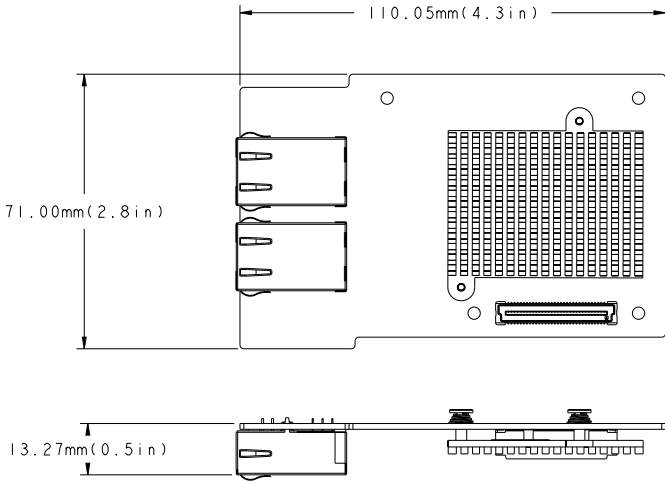

Layout

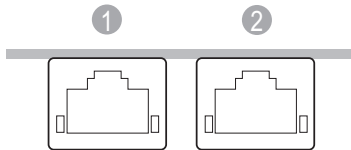

1 LAN RJ-45 Port (LAN1)

2 LAN RJ-45 Port (LAN2)

LAN Port LED Indications

Activity / Link LED

Status	Description
Off	No Link
Blinking	Data Activity
On	Link

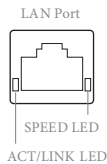

Speed LED

Status	Description
Off	No connection
Orange	1Gbps connection
Green	10Gbps connection

MP-4223R4

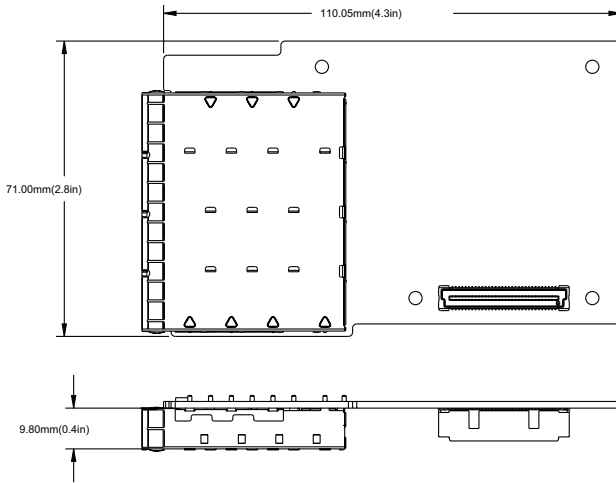

Layout

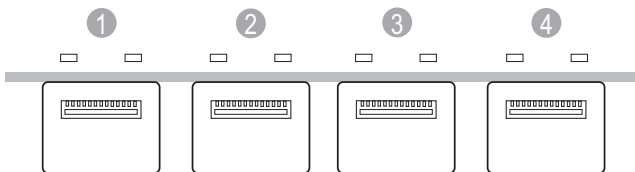

- | | | | |
|---|------------------------------|---|------------------------------|
| 1 | 10G SFP+ (Fiber) (SFP+_CON1) | 3 | 10G SFP+ (Fiber) (SFP+_CON3) |
| 2 | 10G SFP+ (Fiber) (SFP+_CON2) | 4 | 10G SFP+ (Fiber) (SFP+_CON4) |

LAN Port LED Indications

Activity / Link LED

Status	Description
Off	No Link
Blinking	Data Activity
On	Link

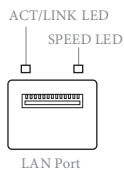

Speed LED

Status	Description
Off	No connection
Orange	1Gbps connection
Green	10Gbps connection

MP-4227R2

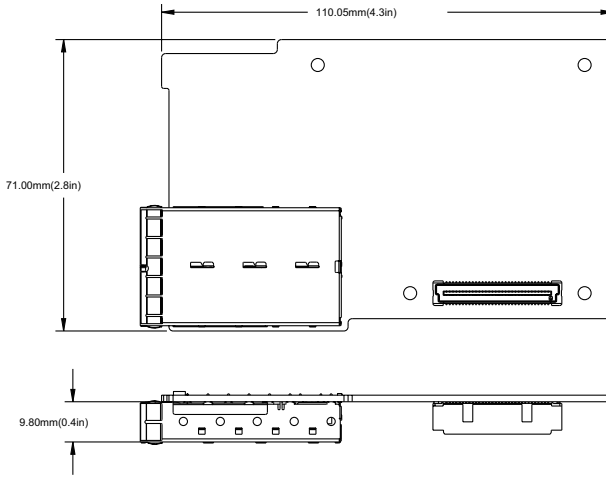

Layout

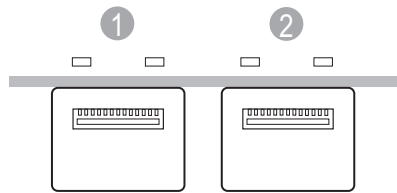

1 10G SFP+ (Fiber) (SFP+_CON1)

2 10G SFP+ (Fiber) (SFP+_CON2)

LAN Port LED Indications

Activity / Link LED

Status	Description
Off	No Link
Blinking	Data Activity
On	Link

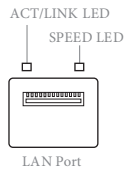

Speed LED

Status	Description
Off	No connection
Orange	1Gbps connection
Green	10Gbps connection

Mezzanine PHY Card Installation

Before installing a mezzanine card to a motherboard, remove the motherboard from the chassis. To do so, be sure to power down the system and remove all connected cables first. For more details, refer to the user manual that comes with your system.

**The illustrations are for reference only and may be slightly different from the real products due to different models.*

1. Install the four spacer supports into the motherboard around the mezzanine card slot.

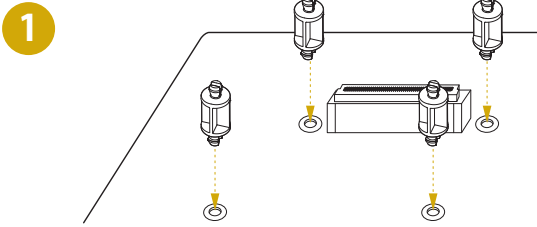

2. Gently insert the mezzanine card into the mezzanine card slot on the motherboard.

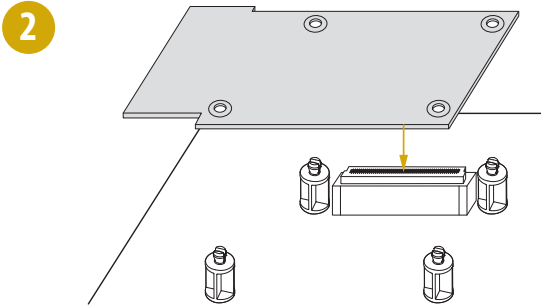

When the mezzanine card is well installed, horizontally slide the motherboard back to the chassis so the I/O connectors fit through the I/O openings at the rear of the chassis. Well install the motherboard to the chassis with screws.

Simply squeeze the top of each spacer support to release the mezzanine card.

